

Article number: 20992D30M10

Description: E+G Threaded end-caps - GN 992-D30-M10

Measures

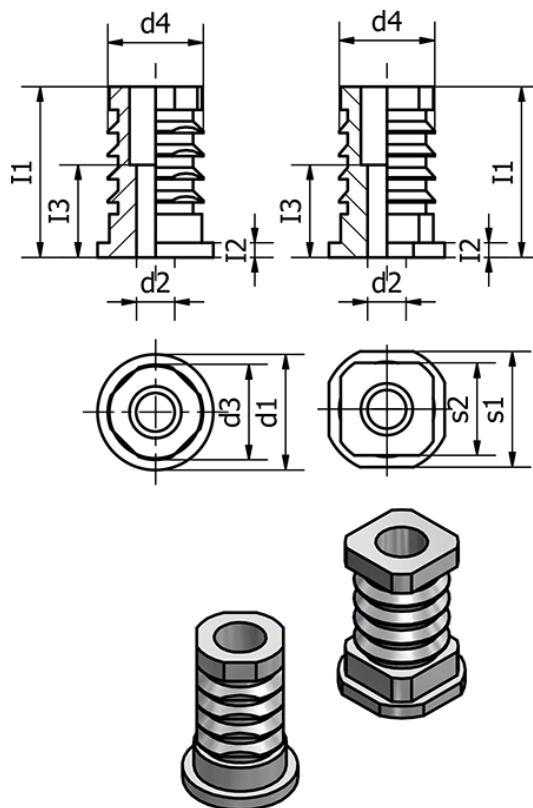

d1 = D30

d2 = 10

d3 = 26

d4 = 26.5

I1 = 33.5

I2 = 2.5

I3 = 18

s1 =

s2 =

Weight (g) = 45